



COMPREHENSIVE CLEANROOM SERVICES



CleanRoom

RENEX GROUP

A FEW WORDS **ABOUT US**

CLEANROOM brand is part of **RENEX** Group, that specializes in providing comprehensive services and equipment necessary for creating and proper operation of cleanrooms.

Many years of experience and technological facilities in all areas of the Group's operations allow us to provide state-of-the-art solutions based on expertise in many fields.

We are a Polish manufacturer with professional production and R&D facilities. Under our own brand - REECO - we supply ESD and Cleanroom clothing, specialized furniture, passboxes and cleanboxes in standard configurations and customized according to the customer's needs.

For more information, visit the website:

RENEX.PL



EQUIPMENT



MEASUREMENT AND CONTROL

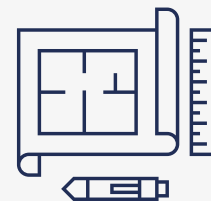

DESIGN



INSTALLATION





CLEANROOM **MAINTENANCE SERVICES**



CLEANROOM MAINTENANCE SERVICES

AUDITS AND ASSESSMENTS

Audits and assessments of air quality levels in all ISO class standards.

CLEANING

Specialized cleaning of clean zones including ISO class standard 4 and lower.

MAINTENANCE

Maintenance work to ensure that required operational parameters are kept.

EQUIPMENT MAINTENANCE

Maintenance of industry-specific cleanroom equipment.

Clean zones require the implementation and maintenance of continuous monitoring and cleaning procedures.

Deviations from these procedures lead to an increase in the contaminants present in the room - such as the level of particles in the air, and as a consequence a change in the cleanliness class of the room.

Failure to meet declared classes of cleanliness can, as practice shows, often form the basis for claims by contractors.

The solution to this problem is to entrust the service of clean zones to a specialized third-party company.



AUDITS AND ASSESSMENTS

All activities are carried out by a specialized team.

This ensures that there is no risk associated with employee work routine.

Often the company's in-house employees are prone to gradually deviate from and neglect procedures.



CLEANING

All assessments are carried out by an impartial entity, resulting in reliable results.

There is no danger of biased reporting by in-house staff.



MAINTENANCE

Each service is completed with a full report on the found state of the clean zone and a list of actions performed.

Complete documentation throughout the clean zone's operations prepares the room for inspection audits and audits by external entities.



EQUIPMENT MAINTENANCE

There is no need to train employees in the service of clean zones, to supervise the application of procedures, nor to purchase specialized measuring equipment and cleaning products.

CLEANBOX – **MOBILE CLEAN ZONE**

Reeco
Cleanroom



Reeco
Cleanroom

CLEANBOX | CONSTRUCTION DIAGRAM

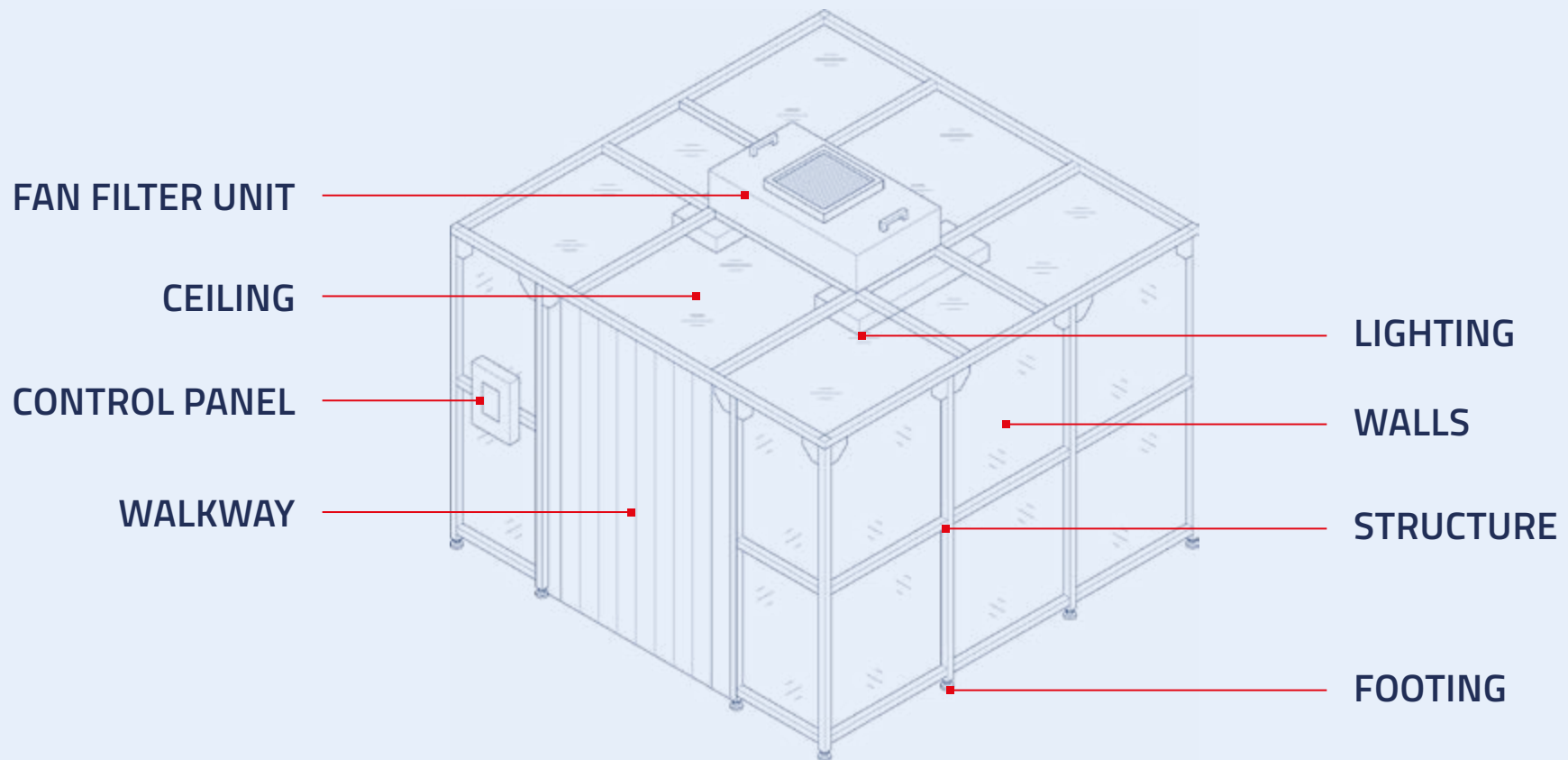

CLEANBOX | WALLS AND CEILING



We use only proven solutions with the highest quality materials.

Wall options:

- 0.3 mm thick antistatic foil
- mesh (carbon lines)
- anti-static lamella curtains

Available ceiling:

- steel panels coated with antistatic powder paint

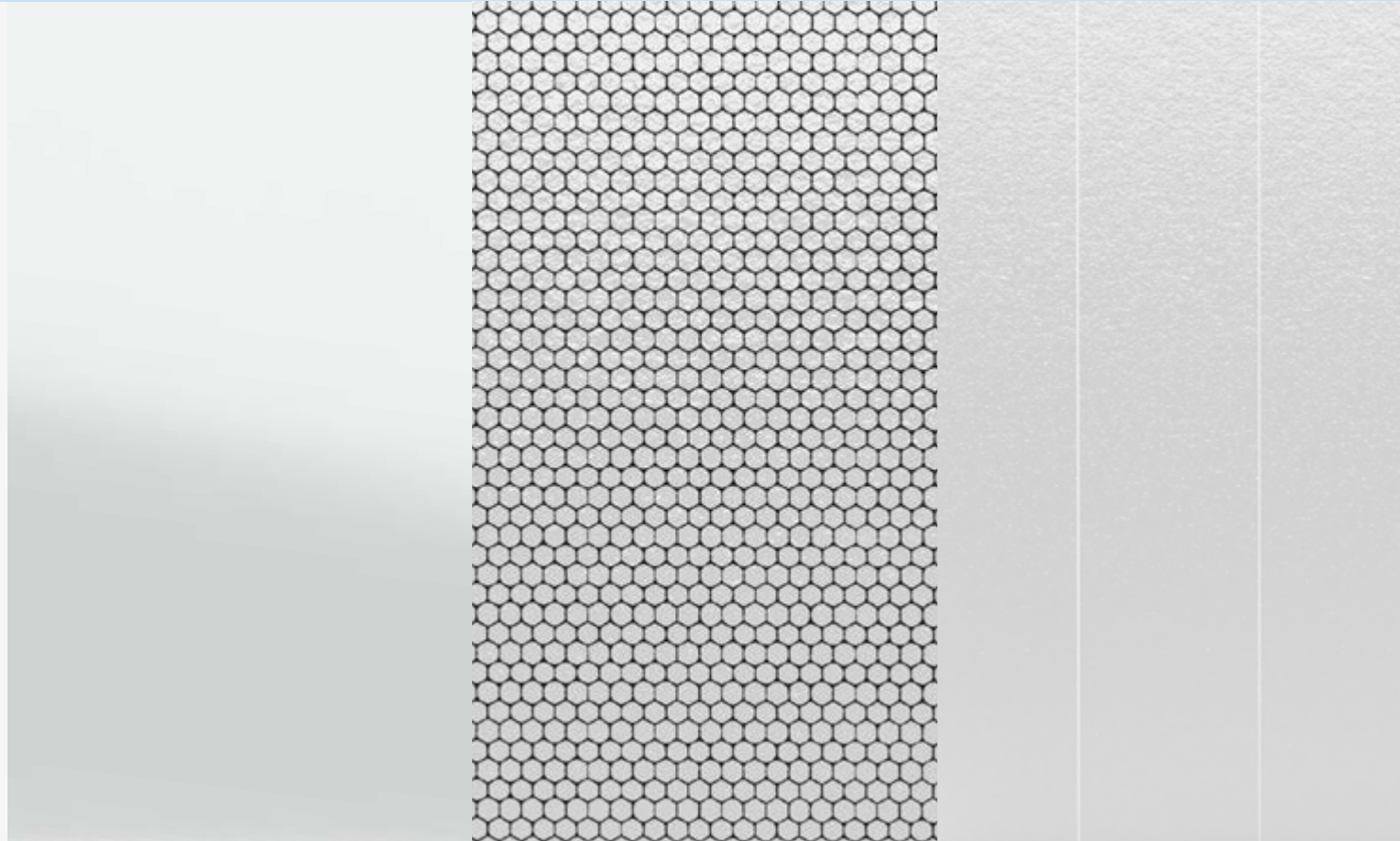

ACRYLIC GLASS

ANTISTATIC
PVC FILM

PVC ANTI-STATIC
LAMELLA CURTAIN

CLEANBOX | WALKWAY



The walkway must allow free movement of people and goods.

We adapt the width, height and design of the walkway individually to each process and customer requirements.

Optional choices include:

- PVC strip curtains
- PVC antistatic strip curtains
- door

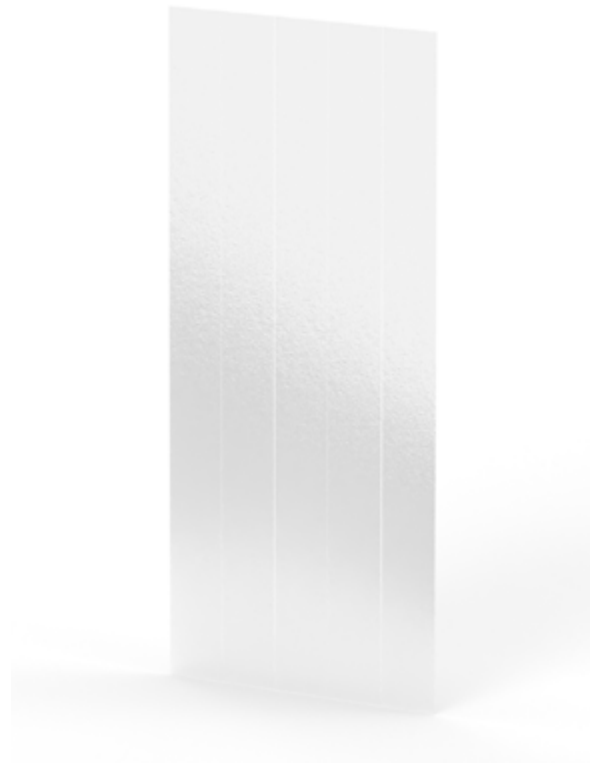

PVC STRIP CURTAINS

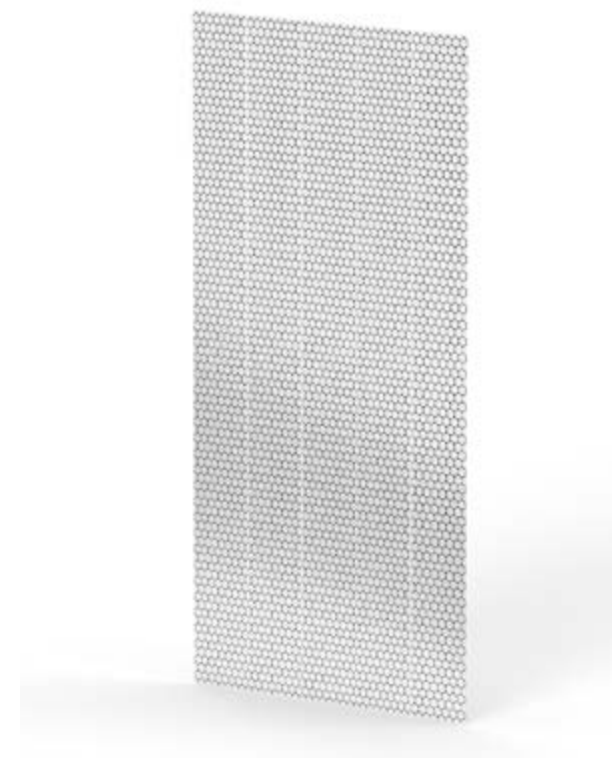

PVC ANTISTATIC STRIP CURTAINS

CLEANBOX | FOOTING



Before installing a mobile cleanroom, consider the type of footing.

Selectable options:

- ESD technopolymer feet with galvanized threaded shank
- wheels with aluminum hub and ESD polyurethane tread, swivel with brake

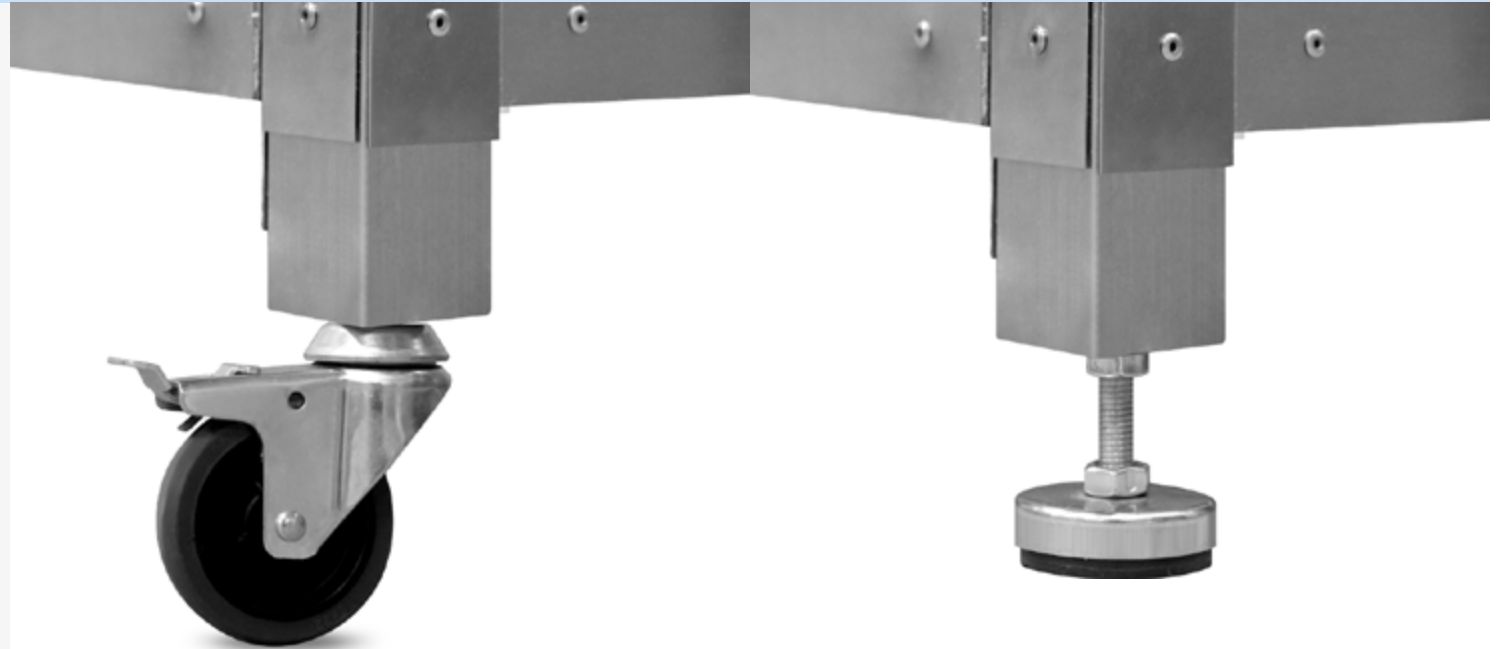

CASTERS

They make it easy to store or move to another facility without disassembling the construction.

FIXED FEET

Recommended for larger structures

CLEANBOX | LIGHTING

Reeco
Cleanroom

CleanBox is equipped with technical lighting for rooms with a high degree of sterility depending on the classification of the room.

We will ensure that the lighting is tailored to individual needs. Both those made for different types of cleanroom facilities and luminaires with increased fire resistance (REI 20, REI 180)



CLEANBOX | FAN FILTER UNIT



The basis for proper functioning of CleanBox is fan-filter units.

They are equipped with a set of filters whose task is to clean the air to the required quality.

Advantages:

- Adjustable air speed, controlled manually or remotely
- Low noise emissions
- Reduced vibration level

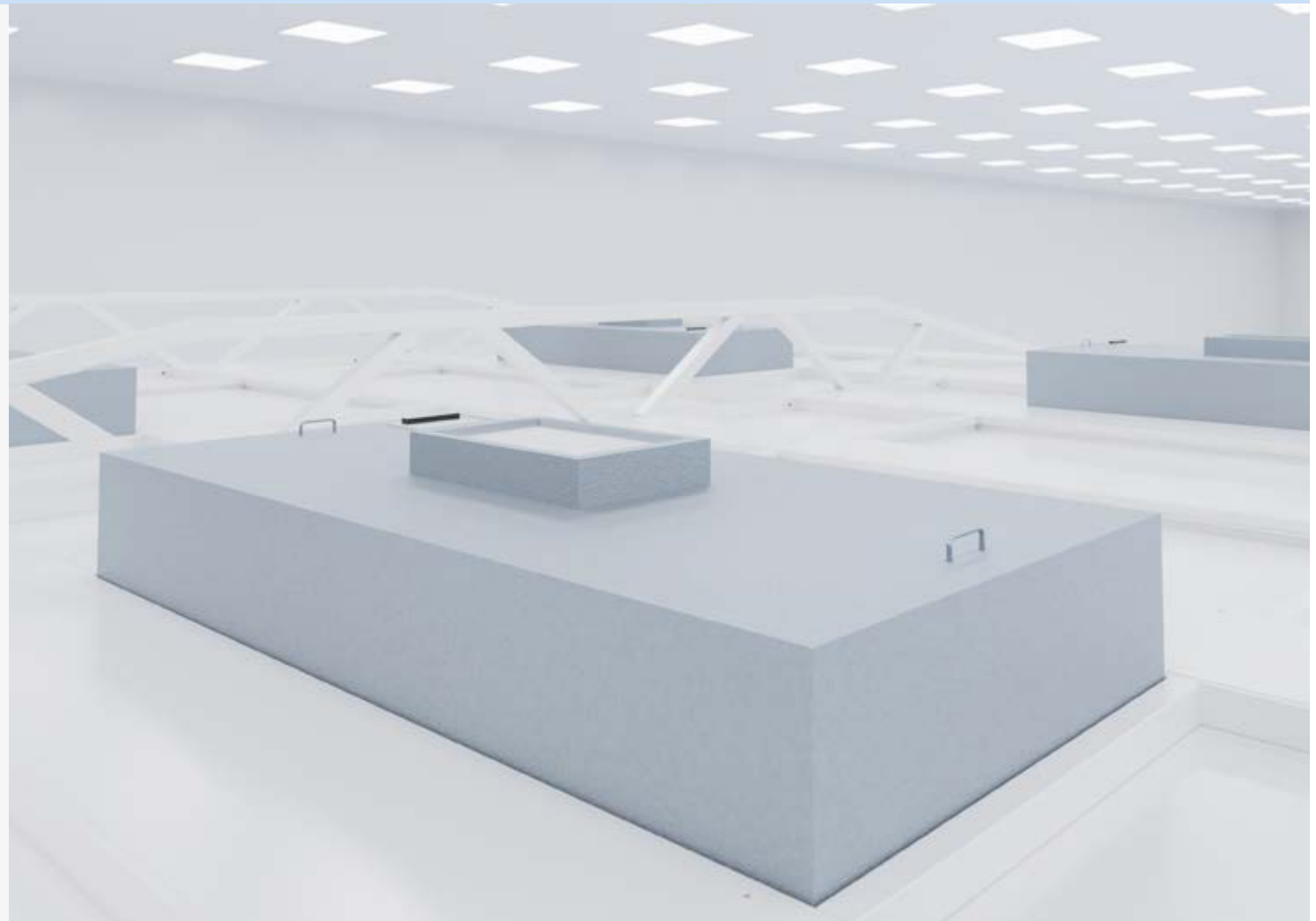

CLEANBOX | FAN-FILTER UNITS



Fan-filter unit:

- fan filter unit with HEPA filter H13/14
- Cold-rolled steel construction with galvanic coating
- air velocity 0,35-0,55 m/s
- fan efficiency 800-1200m³/h
- noise level <63 dB
- single or group control
- weight 27-40 kg
- power supply 230 V 50/60 HZ

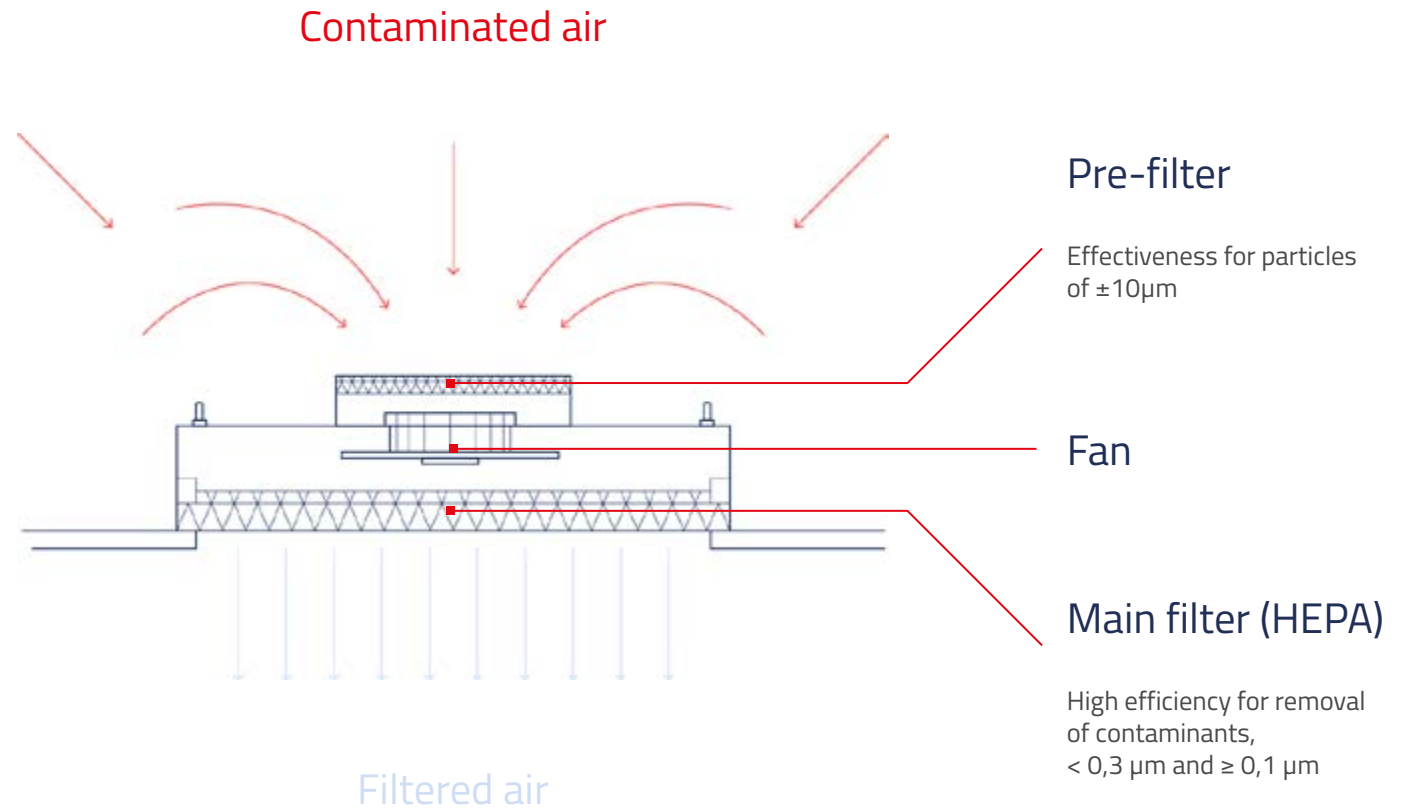

CLEANBOX | FILTER CLASSIFICATION



Class	Total filtration efficiency	Local efficacy	Application
HEPA H13	99,95%	99,75%	<ul style="list-style-type: none"> ▪ Pharmaceutical industry ▪ Air purifiers ▪ Vacuum cleaners ▪ Air conditioners
HEPA H14	99,995%	99,975%	<ul style="list-style-type: none"> ▪ Higher standard hospitals ▪ Air purifiers ▪ Vacuum cleaners ▪ Air conditioners
ULPA U15	99,9995%	99,9975%	<p>Manufactured for locations that must meet very stringent air quality requirements:</p> <ul style="list-style-type: none"> ▪ Nuclear industry ▪ Pharmaceutical industry ▪ Pyrotechnic industry
ULPA U16	99,99995%	99,99975%	<ul style="list-style-type: none"> ▪ Power industry ▪ Food industry
ULPA U17	99,999995%	99,9999%	<ul style="list-style-type: none"> ▪ Food industry

CLEANBOX | ADVANTAGES



MOBILITY

Thanks to its light weight and specialized design, the Cleanbox can be easily moved to another location. This makes it possible to dynamically adapt the production space to the required conditions.

LIGHTWEIGHT DESIGN

Expertly designed construction, ensures that any modifications or changes in the position of Cleanbox are not a problem.

MODULARITY

The modular design makes it very easy to expand the Cleanbox in almost any way you want. This is a huge advantage over a traditional clean room, the expansion of which usually involves the construction of a new room.

NO COMPLEX PROCEDURES AND BUILDING PROJECTS

The installation of Cleanbox is incomparably faster and easier than the construction of a standard cleanroom. There is no need of complicated and time-consuming construction projects.

LESS TIME-CONSUMING PROCESS

From design to construction and service, installing a mobile clean room is incomparably faster than building a conventional clean room.

LOWER INVESTMENT AND MAINTENANCE COSTS

As in the case of time, thanks to its characteristics, the cost of installing and servicing a Cleanbox is orders of magnitude lower than that of standard clean zones.

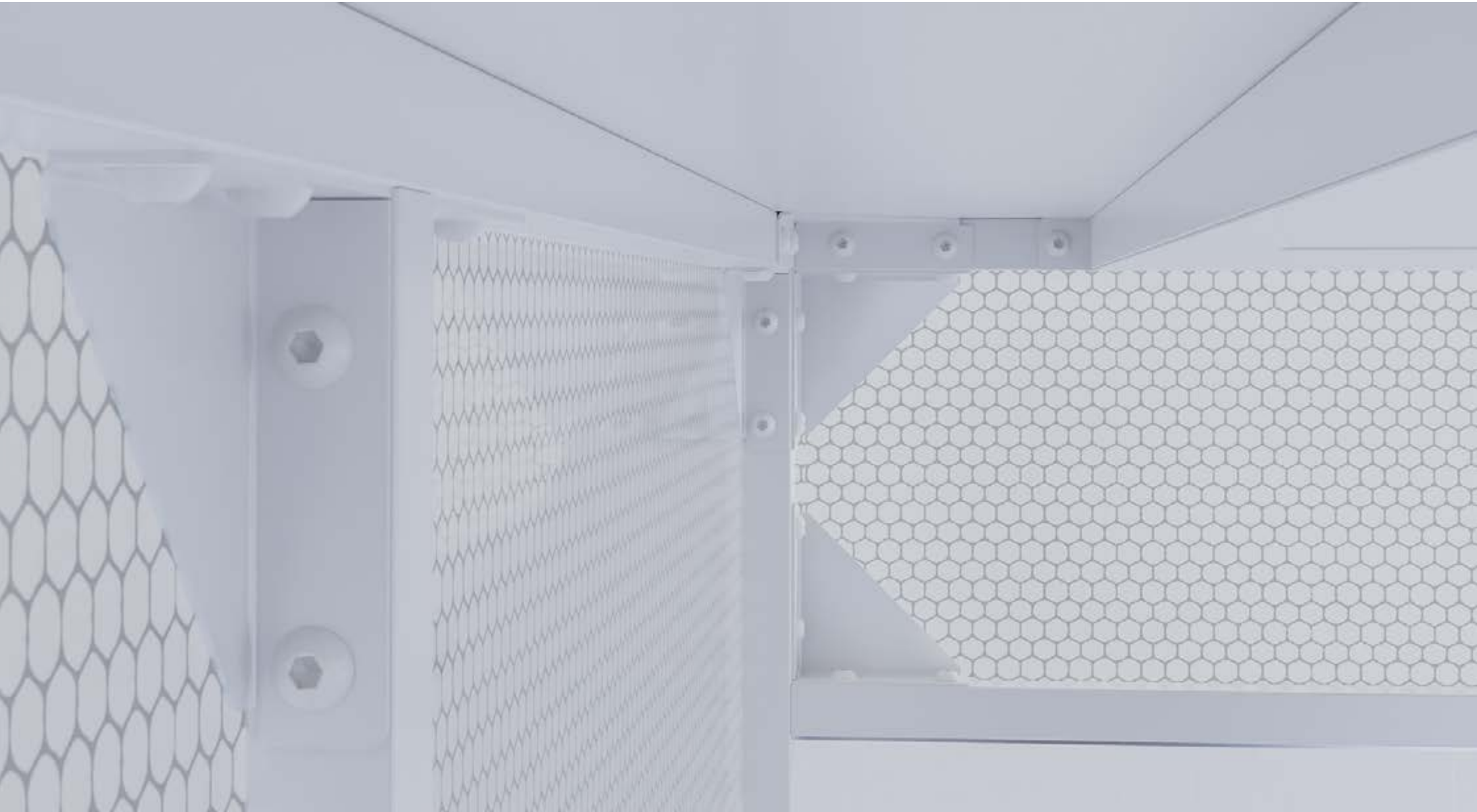

CLEANROOM **EQUIPMENT**



CLEANROOM EQUIPMENT

We offer a wide range of high-quality products dedicated to all ISO class standards.

We provide equipment for a number of industries:

MEDICAL

PHARMACEUTICAL

BIOTECH

ELECTRICAL

AVIATION

SPACE

FOOD

AUTOMOTIVE

PROFESSIONAL LABORATORY FURNITURE



Equipping a laboratory with the right furniture makes a measurable difference in terms of workflow, safety, and operator productivity and comfort.

Laboratory benches, chairs, stools, tables, work surfaces and storage cabinets are used in all types of facilities, including medical, chemical and life science laboratories.

Reeco cabinets

While capacity and space are important factors when choosing storage cabinets, safety should be a priority.

Chemical storage cabinets can be ductless, connected to an existing fumigation system or have a built-in filter system.

All REECO cabinets perform exactly these functions.



ANTISTATIC PROTECTION



The design of REECO furniture provides full protection against electrostatic discharge.

The frame of REECO furniture is protected with antistatic coatings.

The desktops are made and laminated with conductive materials to ensure the outflow of electrostatic charges from the surface to ground.

All our products meet the requirements of the PNEN- 61340-5-1:2009 standard.



SPECIALIZED ESD FURNITURE



From the very beginning of RENEX Group, we have been guided by high quality of our products. The culmination of these efforts is REECO antistatic industrial furniture.

Our product range includes anti-static industrial tables, anti-static chairs, workplace lighting, storage systems, transport systems, cabinets, carts and hanging cabinets.

All REECO antistatic industrial furniture is characterized by antistatic (ESD safe) properties. A great and unique advantage of REECO industrial furniture is its modularity - it allows you to customize your workstation to meet any need. Whether you need furniture for an electronics technician, for a laboratory, or research and development centers, government institutions, scientific institutions, or ordinary production tables - REECO industrial furniture will do the job perfectly.

We also offer specialized furniture, such as anti-vibration or anti-bacterial tables. If you are looking for workshop furniture, production tables or simply ergonomic and durable industrial equipment.

REECO antistatic workshop furniture is made for you!





ESD AND CLEANROOM CLOTHING

Reeco

Comfort of use and safety at work.

We offer the highest quality antistatic clothing, which perfectly protects against electrostatic discharges. The manufacturer of all offered antistatic clothing is a Polish brand - REECO. We also offer the possibility to make any embroidery on the ordered ESD clothing.

Each product is available in several color and size variants - so that each person can adjust the clothing to their individual needs. With our comprehensive range of anti-static protection, you can purchase all the ESD protection you need in one place. When you order ESD clothing from REECO, you are guaranteed high quality at an affordable prices.

- Variety of materials
- Wide range of colors
- Possibility of personalization (embroidery)

Clothing meets the requirements of standards:

- PN-EN 1149-5
- PN-EN ISO 13688
- PN-EN 61340-5-1





PASS BOXES

Cargo airlocks, also known as pass boxes, allow the transfer of parts and equipment into and out of the clean room.

Pass boxes are small cargo airlocks placed in partition walls between rooms in pharmaceutical plants, laboratories and hospitals. They play a particularly important function when the rooms they connect have different classes of cleanliness or there is a pressure difference between them.

Pass boxes allow quick and safe transfer of samples, packaging materials and instruments between rooms, reducing time and minimizing the possibility of cross-contamination.

Because of their small size, they limit the movement of particles and have very little impact of pressure differences between rooms.

These specialized entry systems reduce the need to enter clean rooms, and with less traffic in the clean room, contamination is significantly reduced.



PASS BOXES

Advantages of using pass boxes:

- minimizing the risk of contamination during the production or research process
- maintaining the desired ISO classification in a given zone
- positive impact on the quality and integrity of products and processes
- matching the pass box model to a given type of risk in relation to materials and products (passive, active-HEPA, biological-UV)
- the possibility to plug into the existing filtration system of the facility

Design

- external casing - powder-coated steel with antistatic paint or 304 stainless steel
- internal construction - 304 stainless steel

Doors

- lock: cross lock- electromagnetic
- stainless steel concealed hinges
- glazing: insulated safety glass
- stainless steel handle
- power supply 230V 50/60 Hz

Options

- possibility of different configurations and dimensions depending on room design and customer requirements



ACTIVE PASS BOXES



AIR SHOWERS



CLEANROOM CLOTHING

Reeco
Cleanroom



CLEAN BENCHES



DOORS AND **GATES**



WALL **PANELS**

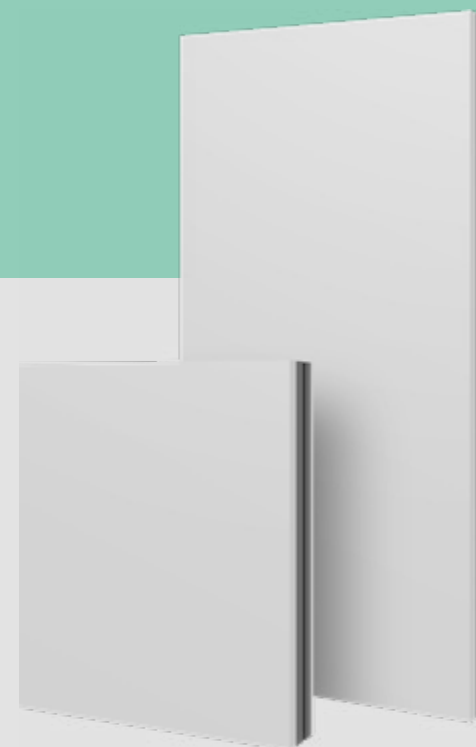

DECONTAMINATION **MATS**

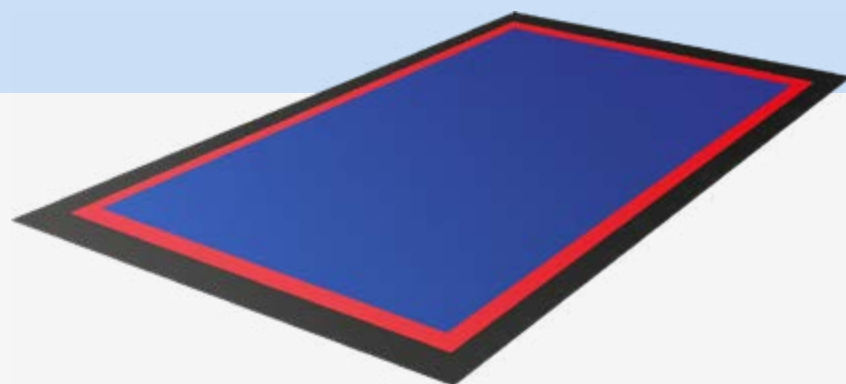

FILTRATION **SYSTEMS**



LABORATORY FURNITURE



CLEANING SUPPLIES



GLOVE BOXES

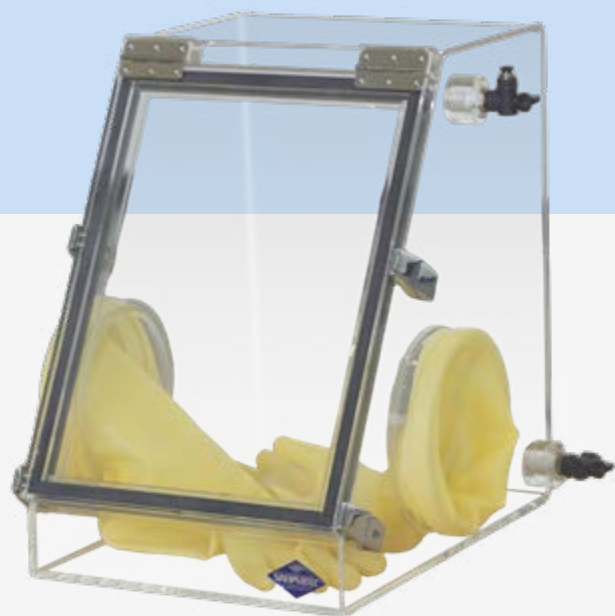

VACUUM DESICCATORS



PASSIVE PASS BOXES

Reeco
Cleanroom



CLEANROOM ACCESSORIES





Reeco

Cleanroom



Reeco

HEADQUARTERS - POLAND

Al. Kazimierza Wielkiego 6E
87-800 Włocławek, POLAND

OFFICE

T: 54 411 25 55
T: +48 601 270 500
E: office@cleanroom.com.pl

SERVICE

T: +48 885 111 160
E: serwis@cleanroom.com.pl

PRODUCTION

T: +48 601 271 555
E: produkcja@cleanroom.com.pl

cleanroom.com.pl

